





Koral 207



Dotazione standard | Standard equipment | Standardausrüstung

	1150	Portacucchiaini Teaspoons insert Löffelchenhalter	1
	1153	Portapiattini 12 pz Saucer holder 12 pieces 12-Stück Untertassenhalter	1
	207054	Cesto quadrato per bicchieri 35x35x15 cm Square basket for glasses 35x35x15 cm Quadratischer Gläserkorb 35x35x15 cm	2
	207035	Cesto rotondo ø35 cm Round basket ø35 cm Runder Korb ø35cm	a richiesta on request auf Anfrage

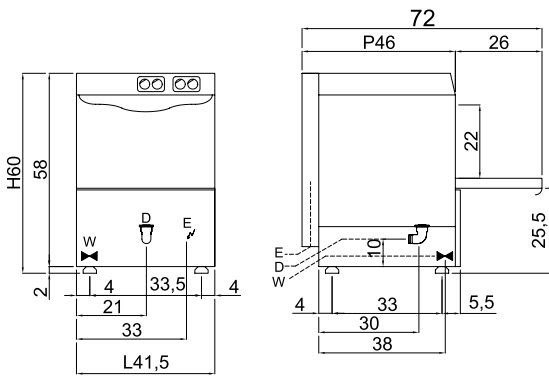

E Collegamento elettrico
Electric connection
Elektrische Verbindung

D Scarico acqua Ø 22
Water Drain Ø 22
Wasserablauf Ø 22





W Carico acqua 3/4"
Water inlet 3/4"
Wasseranschluss 3/4"

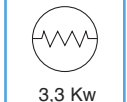
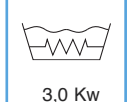
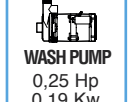

Imballo | Packing | Verpackung

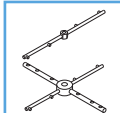
	Dimensioni Dimensions Maße Volume Volume Volumen Peso Weight Gewicht	49x63x75 cm 0,23 m ³ 35 Kg
---	--	---

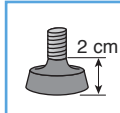
 TOTAL POWER 3,5 Kw	 3,3 Kw	 3,0 Kw	 WASH PUMP 0,25 Hp 0,19 Kw
--	---	---	---

 35 cm	 20 cm		 120 sec.	 V 230/1+T Hz 50/60	 +55° C	 2 cm	 <70 dB	 ecologycare	
--	--	---	---	--	---	--	---	--	---